



MANITOU MT 1840 PRIVILEGE

MT 1840 MT 1840 EP **PRIVILEGE**

 **Lifting capacity**4000 kg
at 500 mm from forks heels.
Tipping load at maximum reach :
with stabilizers950 kg
Tear out force with bucket
to ISO 83138000 daN

 **Lifting height**17.50 m
Times : unladen / loaded (in s)
Lifting (standard)17/17.1
Lifting (EP)12.1/12.2
Lowering14.5/14.3
Extension boom27.5/33
Retraction boom26.4/25.5
Crowd4.3
Dump4

 **Tyres**440/80-24

 **Forks (mm)**
Length1200
Width x thickness125 X 50
Maximum distance between forks1040
Carriage rotation126°

 **Multidisc brakes - hydraulically assisted on both axles**

 **PERKINS Engine**
Type1104C.44 T
Capacity4 cylindres - 4400 cm³
Power :
(ISO/TR 14396) ...101 HP/74.5 kW at 2350 rpm
Maximum torque413 Nm at 1350 rpm
Direct Injection
Water Cooling

 **Transmission**Torque convertor
Electro-hydraulic reversing shift
4 speeds forward and reverse
Maximum travel speed (km/h)25

 **Hydraulics**
Pumpgear type
Pressure/capacity270 bars/170 l/mn

 **Capacities**
Cooling system20 l.
Engine oil10.9 l.
Hydraulic oil135 l.
Transmission oil23 l.
Fuel tank140 l.

 **Weight unladen**11380 kg
Overall width2.40 m
Overall height2.50 m
Turning radius (outside wheels)3.99 m
Overall Length6.27 m
Ground clearance0.44 m
Drawbar pull10300 daN

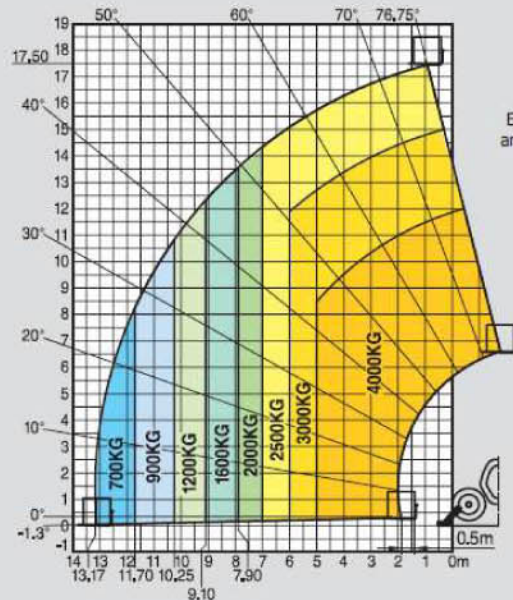

A	1200
B	3070
C	2044
C1	1929
D	6270
D1	6159
D2	4886
E	7473
F	1960
F1	1960
G	437
G1	420
G2	433
G3	302
H	9°
H1	9°
I	1160
J	892
K	1040
L	50
N	1908
O	125
P2	37°
P3	34°
R	3779
S	8780
T	4307
U1	2505
U2	2693
V	5592
V1	1285
V2	3998
W	2397
W1	3793
W2	1134
W3	2422
Y	12°
Z	114°

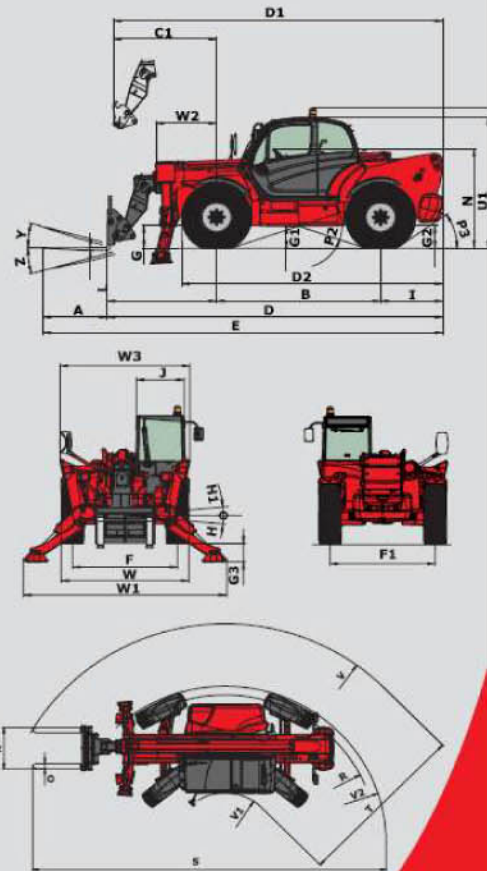

WINNER HANDLING

SUSSEX: 01903 230700

SURREY: 01483 456789

EMAIL: SALES@WINNERHANDLING.CO.UK